



**PEGASUS®**

# M900

TO USE THE MACHINE SAFELY

機械を安全にお使い頂くために

Um die Maschine sicher zu benutzen

Pour utiliser la machine en toute sécurité

Para utilizar la máquina de forma segura

为了安全使用本产品

M932 Series: Safety stitch machine

M952 Series: Overedgers

M922 Series: Double chainstitch machine

**IMPORTANT:**  To use the product safely, please be sure to read the WEB instruction manual by accessing our website before use. The QR code and URL for our website are as follows. Also, please keep this manual in a safe place.

**重要：**  製品を安全にお使いいただくため、ご使用前に以下のQRコードまたはURLより当社WEBサイトにアクセスしていただき、WEB取扱説明書を必ずお読みください。また本書は大切に保管してください。

**WICHTIG:**  Zur sicheren Produktverwendung die WEB Bedienungsanleitung auf unserer Website vor Betrieb unbedingt lesen. Den QR-Code und die URL für unsere Website finden Sie unten. Bewahren Sie außerdem diese Bedienungsanleitung an einem sicheren Ort auf.

**IMPORTANT:**  Afin de garantir la sécurité d'utilisation du produit, lire impérativement le mode d'emploi sur notre site web avant la première utilisation. Vous trouverez ci-dessous le code QR et l'URL de notre site web. Conservez ce mode d'emploi dans un endroit sûr.

**IMPORTANTE:**  Para usar el producto de forma segura, es preciso ir a nuestro sitio web para leer previamente nuestro manual de instrucciones WEB. El código QR y la URL para el acceso a nuestro sitio web vienen indicados abajo. Además, guarde este manual en un sitio seguro.

**重要的：**  为了安全使用本产品，请于使用前通过以下二维码或者网址访问本公司网站，请务必阅读网页版使用说明书。另外，请妥善保管本手册。

QR code:



URL: <https://www.pegasus.co.jp/bit/hcf6i4>

## 1. Introduction

- This is the instruction manual that describes how to use this product safely.
- Read this instruction manual and the instruction manual on the web and learn very carefully how to operate, adjust and service the sewing machine, automatic machine and labor saving device or this product (hereinafter collectively referred to as “machine”) before beginning any of the procedures.
- You should realize first that there is always the risk of contacting moving parts, such as needles because you have to work at point-blank range to them when you are operating industrial sewing machines. For safety it is essential that we supply safe products and you use them correctly and safely. There may be some safety measures that you yourself must take. Therefore, you should read and understand very carefully this instruction manual together with that of the driving equipment and take necessary safety measures in order to use this machine efficiently and effectively.

## 2. Indications of dangers, warnings and cautions



To prevent accidents, indications (symbols and/or signs) which show the degree of danger are used on our products and in this manual. Study the contents very carefully and follow the instructions.

Indication labels should be found easily.











Attach new labels when they are stained or removed.

Contact our sales office or representative when new labels are needed.

### Symbols, signs and/or signal words which attract users' attention

	<b>DANGER</b>	Indicates an immediate hazard to life or limb.
	<b>WARNING</b>	Indicates a potential hazard to life or limb.
	<b>CAUTION</b>	Indicates a possible hazard that could result in injury or damage.

## Symbols and messages

	Be sure to follow the instructions when you operate the machine and/or labor saving device.
	If you use the machine and/or labor saving device incorrectly, you may get an electrical shock.
	If you use the machine and/or labor saving device incorrectly, your hands and/or fingers may be injured.
	If you use the machine and/or labor saving device incorrectly, your fingers and/or hands may be caught in them, causing trouble.
	If you use the machine and/or labor saving device incorrectly, you may burn yourself.
	If you use the machine and/or labor saving device incorrectly, you may cause fire.
	Never do this.
	Unplug the machine and shut off the power when checking, adjusting and/or repairing the machine and/or labor saving device, or when lightning may strike.
	Be sure to connect to ground .
	Read carefully before use. Keep for future reference.
	Denotes the normal rotating direction of the machine pulley.

### 3. Safety precautions

- The content of all section includes items which are not contained in the specifications of your product.
- Those who use a heart pacemaker have to use the machine after consultation with a medical specialist.

#### ① Applications, purpose

This product is applied to the machine used in the sewing industry, particularly in sewing clothing.

Our industrial sewing machines have been developed in order to increase quality and/or production in the sewing industry. Accordingly never use our products for other than intended use described above.

## DANGER



(1) Do not open the control box in order to prevent accident leading to electrical shock. Touching areas where high voltages are present can result in severe injury or death.

#### ② Circumstances

The environment in which our machines are used may seriously affect their lives, functions, performance and/or safety.



For safety, do not use the machine under the circumstances below.

1. Do not use the machine near objects which make noise such as a high-frequency welder, etc.
2. Do not use or store the machine in the air which has vapor from chemicals, or do not expose the device to chemicals.
3. Do not use the machine and/or the device out of doors or in direct sunlight.
4. Do not use the machine and/or the device at the ambient temperature of less than 5 degrees C or more than 35 degrees C.
5. Do not use the machine and/or the device at the humidity of less than 35% or more than 85%.
6. Do not use the machine on the condition that the voltage fluctuation range is more than  $\pm 10\%$  of the rated voltage.
7. Do not use the machine in the place where the supply voltage specified for the control motor cannot be properly obtained.
8. Do not use the device at the place where the air supply specified for the device cannot be properly obtained.
9. Do not expose the machine to the water.
10. Do not use in potentially explosive atmosphere.

#### ③ Safety measures



(1) Safety precautions when you perform maintenance on the machine.

- Always turn off the power, unplug the machine and then make sure that the machine does not run by pressing the treadle before performing any maintenance, such as checking, repairing, cleaning, etc. However, if you need to perform these procedures with the power on, to prevent accidents due to the unexpected start of the machine and users' misoperation, establish your procedures for safety and follow them.



● Always turn off the power and unplug the machine before performing the procedures shown below.

- Sewing machine installation
- Lubrication
- Silicone oil for H.R. device
- Installing each component
- Connecting cords
- Oil replacement
- Checking and replacing the oil filter
- Threading
- Replacing the needle
- Opening/closing the presser bar
- Adjusting the stitch length
- Replacing and adjusting the knife
- Cleaning
- Replacing the oil
- Changing the fulcrum on the presser foot
- Adjusting the needle thread take-up
- Adjusting the thread take-up
- Adjusting the pressure exerted by pressing the treadle with the toe/heel

● Only authorized technicians are allowed to perform routine daily maintenance and/or repair the machine.



● Do not modify the machine yourself.

※ Consult you local Pegasus' sales office or representative for modification



(2) Before operating the machine

● Check the machine head and unit for any damage and/or faulty function at the start of each day.

If there should be something wrong with the machine, immediately perform repairs and/or other necessary procedures.

● Check by hand to see if the needle holder is secured. ※ Be careful of the needle point.

● Before starting the machine, make sure that the presser foot is positioned correctly (turn the machine pulley slowly by hand to see if the needle point is centered in the needle drop hole on the presser foot). (Fig. 1)

● Check to see if the presser foot is secured (raise the presser foot by the foot lifter and press it by hand front to back and left to right). (Fig. 2)

● To prevent accidents, always make sure the safety covers and safety guards are properly secured.

Never remove the safety covers and safety guards.

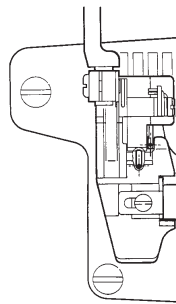

Fig.1

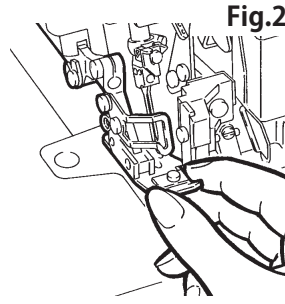

Fig.2



(3) Training

This machine is designed for use by trained operators or supervisors in the sewing industry.

● To prevent accidents, operators and service/maintenance personnel must have proper knowledge and skills for safe operation. To ensure so, managers must design and conduct training for these people.

---

## 4. Notes for each procedure

---



### CAUTION

#### ① Unpacking

1. The machine is packaged in a cardboard box before shipping.

Unpack your machine in orderly sequence while checking them right-side up by referring to the indications, such as logo, etc. printed on the boxes.

2. Never hold the area near the needle and/or thread guide related parts when taking out the machine from the cushion. Otherwise it may cause injury and/or damage to the machine.

3. Take out the machine very carefully while checking the position of the center of the gravity.

4. Keep the cardboard box and packing carefully in case secondary transport is needed in the future.

#### Disposal of the packaging

● The packaging material of the machine consists of wood, paper, cardboard and LDPE and foamed polystyrene. The proper disposal of the packaging is the responsibility of the customer.

LDPE•••Low density Polyethylene

---

## Disposal of machine waste

1. The proper disposal of machine waste is the responsibility of the customer.
  2. The materials used on the machines are steel, aluminum, brass and various plastics.
  3. The machine waste is to be disposed of in accordance with the locally valid environmental protection regulations. A specialist should be commissioned if necessary.
- ※ The parts contaminated with lubricants should be disposed off separately according to the locally valid environmental protection regulations.

## Transport within the customer's premises

- The manufacturer assumes no liability for transport within the customer's premises. Care should be taken to transport the machine in an upright position avoiding it from dropping or falling down to the ground when it is moved.

# WARNING

## ② Transportation

1. The machine should be carried by at least more than two people when it is mounted on the table and/or a hand truck.  
Be sure to use a hand truck for other transportation.
2. To carry the machine, hold the machine pulley tightly with your right hand and the presser bar with your left hand. (Fig. 3)

- ⊘ Never carry the sewing machine by holding the side cover and the control box cover (belt cover). Otherwise injury or death may occur due to falling of the sewing machine in the carrying operation.

If the machine and/or your hands are stained with oil, the machine may be easy to slip out of your hands and fall to the floor. Therefore, wipe off the oil carefully.

3. Care should be taken to avoid excessive shock and shake when the machine is mounted on the table and/or transferred using a hand truck. Otherwise the machine may fall down.
4. Wipe off the oil from the machine before packaging it again for secondary transport. Otherwise the machine may easily slip out of your hands or the bottom of the box may come off while in transit.

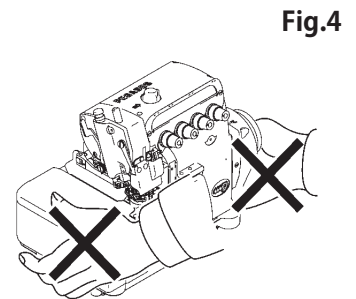
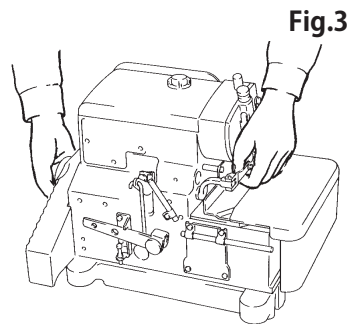

# CAUTION

## ③ Installation, preparation



### Machine table

1. Use the machine table (table board, metal legs) that completely carries the machine and is fully resistant to warping while the machine is running.
2. Arrange the working environment for easy operation by considering where to place the machine and the brightness around the working area. If the illumination is insufficient, control or change lighting as required.
3. Attach a non-slip pad to the treadle (foot switch).  
Otherwise the operator may slip off the treadle while running the machine, causing trouble.
4. Adjust the height of the table according to a working posture of the operator.

---

## WARNING

### Cables

1. When connecting the cables between the machine and the motor, be sure to turn off the power and connect each cable connectors securely.
2. When connecting the cables between the control box and the motor, be sure to turn off the power and connect each cable connector securely.
3. Do not strain the cables in use.
4.  Do not bend the cables excessively.
5. When connecting the cables that are close to the moving parts, such as pulley or V belt, keep a distance of 25mm at least between them.
6. Protect each cable using a cover or adjusting its position if necessary.
7.  Never use staples to fasten the cables.  
Otherwise it causes a short circuit and/or a fire.



## CAUTION

### Motor

1. Install the machine motor correctly by referring to the instruction manual supplied by the manufacturer.
2. Select the machine motor equipped with the pulley cover so that any part of your body etc. is not caught in the belt.





## CAUTION

### Connecting the air lines

1. Always turn off the power first and then connect the air lines to the joints. Be sure to connect all the air lines before connecting them to the air compressor.
2. When connecting the air lines to the joints, be sure to insert the joints to the proper depth of the air lines and fasten securely.
3. Do not allow excessive force to be exerted on the air lines while using the device.
4.  Do not bend the air lines too much.
5. If necessary, protect the air lines by positioning them safely and/or using the cover.
6.  Do not use staples to secure the air lines. Otherwise it may cause damage.

## WARNING

### Connecting the cords

1.  When connecting the power cord, be sure to turn off the power and disconnect the power plug.
2.  Check the voltage designation to make sure the power relay cord matches the local supply voltage. The use of wrong cord may cause damage to parts and/or fire.
3. Do not allow excessive force to be exerted on the cords while using the device.
4.  Do not bend the cords too much.
5. Confirm that the cord is at least 25 mm away from moving part of the machine and/or the device when you connect the cord.
6. If necessary, protect the cords by positioning them safely and/or using the cover.
7.  Do not use staples to secure the cords. Otherwise it may cause damage.

---

## CAUTION

Ground

1. Connect each of the ground wires in the sewing machine system to the ground terminal. Do not connect to another devices'.
2.  Connect the ground wires securely to the indicated ground points on the machine head.

## WARNING



### ④ Handling machine oil

1. Never start the machine with no oil in the reservoir.  
Use Pegasus recommended oil "HIGH SPEED SEWING MACHINE OIL" (ISO VG22).
2. If machine oil gets in your eyes, it may cause eye irritation.  
To prevent the machine oil from getting in your eyes, wear a pair of protective glasses.  
※ Should machine oil gets in your eyes, wash them with fresh water for 15 minutes and then go to see a doctor.
3. Avoid skin contact. Immediately wash contacted areas completely with water and soap.
4.  Never swallow machine oil.
5. Keep machine oil out of the reach of children.
- ※ If swallowed, do not induce vomiting. Immediately go to see a doctor.
6. Dispose of the waste oil and/or containers properly as demanded by law. If you have further questions on its disposal, consult the store or shop at which you purchased it.
7. After opening the oil container, be sure to seal it to prevent dust and water from getting into the oil and keep it in the dark to avoid direct sunlight.

## WARNING

### ⑤ Before starting the machine

Machine table

1. Before turning the power on, visually check the cables and connectors for defective conditions, such as damage, disconnection and/or loosening.
2.  Never bring your hands close to the needle and/or pulley when turning on the power.
3. When the machine is used for the first time, turn on the power and then check the rotating direction of the machine pulley. The machine pulley should turn clockwise as seen from the machine pulley. (Fig. 5)
4. Well trained operators and technicians are allowed to use the machine (the labor saving device) after studying these precautions and the instruction manual carefully.
5.  Regarding symbols that indicate a danger or a warning, read and study "2. Warning indications" carefully and give training on safety to the operators as required.
6. Run the machine at the speed less than 3/4 of its maximum for the first one month.

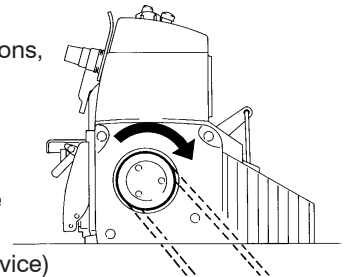







Fig.5

## WARNING

### ⑥ Precautions for work and operation while you are running the machine



1.  Do not run the machine with the safety devices removed, such as needle breakage shield, finger deflector, belt cover, etc.
2.  Do not bring your hands and/or any part of your body close to the presser foot. The area near the presser foot is very dangerous during sewing.
3.  Never bring your hands under the needle while running the machine.



- 
4. A clutch motor keeps on running for a while after the power is turned off. Therefore, be careful even after the power is turned off as the machine could start running by pressing the machine treadle.
  5.  To prevent accidents, never bring any part of your fingers, hair and clothes near the machine pulley, V belt, motor pulley, thread take-up and needle bar. Also never leave scissors, tweezers, tools, etc. around these areas.
  6. Always turn off the power while the machine is not used or before leaving the machine table.
  7. In the event of a power failure, be sure to turn off the power.
  8. While operating the machine, wear clothes that cannot be caught in the machine.
  9.  Do not put any tools or other unnecessary objects on the machine table while running the machine.
  10.  Pay close attention to the knife edges not to injure your hands and/or fingers.
  11. As a health hazard measure, users should wear ear protection as required when the environmental noise level is “over 75 db or under 80 db.” In addition, when the environmental noise level is “over 80 db,” protections notifying the users that they should wear ear protection should be posted.
  12. To prevent accidents, always make sure the safety cover is properly secured.
  13. If any trouble occurs, stop using the machine and turn off the power. Check, repair and/or perform other necessary procedures immediately.

## CAUTION

### Maintenance, Check, Repair

1. Well trained operators and technicians are allowed to perform maintenance, check and repair of the machine after studying these precautions and the instruction manual carefully.
2.  If it is necessary to lay the machine backward for maintenance, check and repair, always turn off the power, unplug the machine and press the treadle to make sure that the machine does not operate before beginning any of the procedures.
3.  Before installing/removing the V belt, always turn off the power, unplug the machine and press the treadle to make sure the machine does not operate.
4. Carry out daily maintenance work and periodical inspections properly by following these instructions and the instruction manual on the web.
5. Employ Pegasus' genuine parts when repairing the machine and/or replacing the parts. We are not responsible for accidents caused by any improper repair/adjustment and substituting other parts for those manufactured by Pegasus.
6. Do not attempt to modify the machine at your own discretion.  
We are not responsible for accidents caused by the modification.
7. Be sure to replace the safety devices and/or safety covers that are temporarily removed for maintenance and/or adjustment.
8. After performing maintenance, check and repair, make sure that turning on the power does not pose any danger to you.
9. To prevent accidents, be careful that any foreign matter such as water, other liquids or metals do not get into the device.
10. If the device is pneumatic, drain and clean the filter regulator periodically. Otherwise the water drainage will flow into the solenoid valve and/or air cylinder, causing trouble.
11. Before and after use, clean lint and any other dust from the machine and/or device. Otherwise it will cause trouble.

5. Location of warning labels and safety devices

**Warning label**

- Moving parts may cause injury.
- Operate with safety devices.
- Turn off main switch before threading, changing bobbin and needle, cleaning etc.

**Knife caution label**

In order to prevent injury to your hands and/or fingers, great care should be taken when you perform the procedures.

**Pulley caution label**

In order to prevent injury, do not let your hands, hair and/or clothes get close to the machine pulley while the machine is running.

**Ground connection label**

Be sure to connect the ground wire. Otherwise electric shock and/or malfunction may occur.

**Electrical-shock danger label**

In order to prevent any electric shock, never open the cover. The supply voltage is AC 200 V – 240V.

**Caution label for the knife shaft link**

Do not get close to the cylinder when the machine is running, in order to prevent injury to your fingers.

**Labels and parts shown:**

- Needle breakage shield
- Cloth plate
- Side cover
- Front cover
- Finger deflector
- Control box cover
- Belt cover
- Ground connection symbol
- Electrical-shock symbol
- Caution symbol with Japanese text: ケガ注意 CAUTION
- Parts: D222, D232, DD3A, AT6F, TK2B, AT8F, Rear cover, Knife shaft cover

## 6. Protectors for safety

This chapter describes each protector for safety. Therefore, read and study the following carefully.



### Protectors for safety

#### (1) Needle breakage shield

Never leave the needle breakage shield open. For the safety of eyes, do not operate the machine with the needle breakage shield open. The needle breakage shield will prevent any pieces of the broken needle from getting into your eyes if the needle should break during sewing. In addition, eye protection is recommended while the machine is being used.

#### (2) Finger deflector

Never insert any of your fingers. To prevent the needle that moves up and down from contacting any of your body, the finger deflector is installed close to the needle. However, there is clearance above the finger deflector for easy threading. Be careful that the needle may penetrate any of your fingers if you insert it into this clearance.

#### (3) Presser foot

Never insert any of your fingers. The presser foot lift (distance from the top surface of the needle plate to the bottom of the presser foot) is more than 5.5 mm except for some machines. Be careful that none of your fingers are caught in this clearance. Never insert any of your fingers under the presser foot when raising the presser foot with the knee switch or automatically raising it with the treadle.

#### (4) Front cover

Never leave the front cover open. The looper travels left to right while drawing an arc as seen from the front of the machine. To prevent the looper from contacting any part of your body, be sure to operate the machine with the front cover closed securely.

#### (5) Cloth plate, side cover

Never leave the cloth plate and/or the side cover open.

To prevent touching the double chainstitch looper thread take-up or looper while the machine is running, operate the machine with the cloth plate and the side cover closed.

#### (6) Pulley

Check the direction in which the machine pulley rotates. It should rotate clockwise as seen from the pulley.

#### (7) Belt cover (except D222, D232, DD3A)

Never remove.

The machine pulley and V belt are covered with the belt cover. The machine pulley and the V belt rotate at high speed during sewing. To prevent accidents, operate the machine with the belt cover installed in place.

#### (8) Control box cover (D222, D232, DD3A)

Never remove.

The control box components are covered with the control box cover. To prevent accidents, operate the machine with the control box cover installed in place.

#### (9) Knife shaft cover (AT6F, AT8F, TK2B)

Never remove the knife shaft cover.

The knife shaft cover covers the rear side of the knife shaft. The knife shaft moves in an arc while the machine is running. In order to protect the body from contact with the knife shaft, never remove the knife shaft cover.

#### (10) Rear cover (AT8F)

Never remove the rear cover.

The rear cover covers the presser foot lift cylinder, the wiring cords and the piping tubes. The rod for the presser foot lift cylinder moves up and down while the machine is running. In order to protect the body from contact with the rod for the presser foot lift cylinder, never remove the rear cover.

## 7. Specifications

### 1. Specifications of the machine head

Stitch type	503, 504, 505, 514, 516, 514+401*
Needle size	DC X 27 #9, #11, #14, #21*
Machine size (WxDxH)	W: 375mm D: 280mm H: 298mm W: 391mm D: 246mm H: 298mm (with D222) W: 391mm D: 260mm H: 345mm (with AT6F)

\*It depends on the subclass. For details, please check the instruction manual on the web.

Net weight (head only)	25.5 kg
Gross weight (with accessories)	33Kg
Max. sewing speed	7000 stitches / minute*
Working noise level	n=6,300rpm : LpA ≤ 82.0dB DIN 45635 48A-1 Noise measurement according to DIN 45635 48A-1

### 2. Specifications of the control box (D222, D232, DD3A)

Rated voltage	Single phase AC 200 V – 240 V ± 10 %
Rated output	550 W

Frequency	50 Hz / 60 Hz
Operating environment	Temperature : 5 °C – 40 °C Humidity : 35 % – 85 %

# ペガサスミシン製造株式会社

本社 〒 553-0002 大阪市福島区鷺洲 5-7-2 TEL (06)6458-4739  
FAX (06)6454-8785

PEGASUS SEWING MACHINE MFG. CO., LTD.  
5-7-2, Sagisu, Fukushima-ku, Osaka 553-0002, Japan. Phone : (06)6458-4739  
Fax : (06)6454-8785

Cat. No. 9B3134000009 March 2022  
©2022 PEGASUS SEWING MACHINE MFG. CO., LTD.

The description in this INSTRUCTIONS is subject to change without prior notice for improvement.